



Instruction

Disassembling and assembling APP 11-13 and APP 16-22



Instruction **Disassembling and assembling APP 11-13 and APP 16-22**

Table of Contents	1.	Disassembling	3
	2.	Disassembling the pump.....	3
	3.	Assembling the pump.....	7
	4.	Disassembling and assembling of the swash plate	12
	5.	Disassembling and assembling of cylinder barrel/valve plate	13
	6.	Disassembling and assembling of the flush valve	14
	7.	APP 11-13, Exploded view	15
	8.	APP 16-19, Exploded view	16
	9.	APP 22, Exploded view	17

This document covers the instructions for disassembling and assembling the axial piston pumps APP 11-13 and APP 16-22.

Tools provided with toolset 180B4222:

- 10 mm combination wrench
- 13 mm combination wrench
- 6 mm allen key
- Adjustable pin wrench
- Press bush for valve plate
- Extractor
- M8x20 mm allen screw
- Press bush (plastic)
- M8 eye bolt
- M8 mm nut
- M8x70 mm screw

1. Disassembling

Important: It is essential that the pump is serviced in conditions of absolute cleanliness.

For a better understanding of the pump, please see exploded views on page 15 to 17.

Place the pump on a pallet or other stable surface above the ground. Ensure that the pump cannot roll. It must be possible to place the pump vertically with the shaft pointing downwards. This can be done between two pallets or between two boards on a pallet provided that the distance to the ground is minimum 100 mm. (3,94 inches). See example page 4 item 7.

WARNING:
Do not reuse disassembled O-rings or shaft seal as they might be damaged. Always use new O-rings.

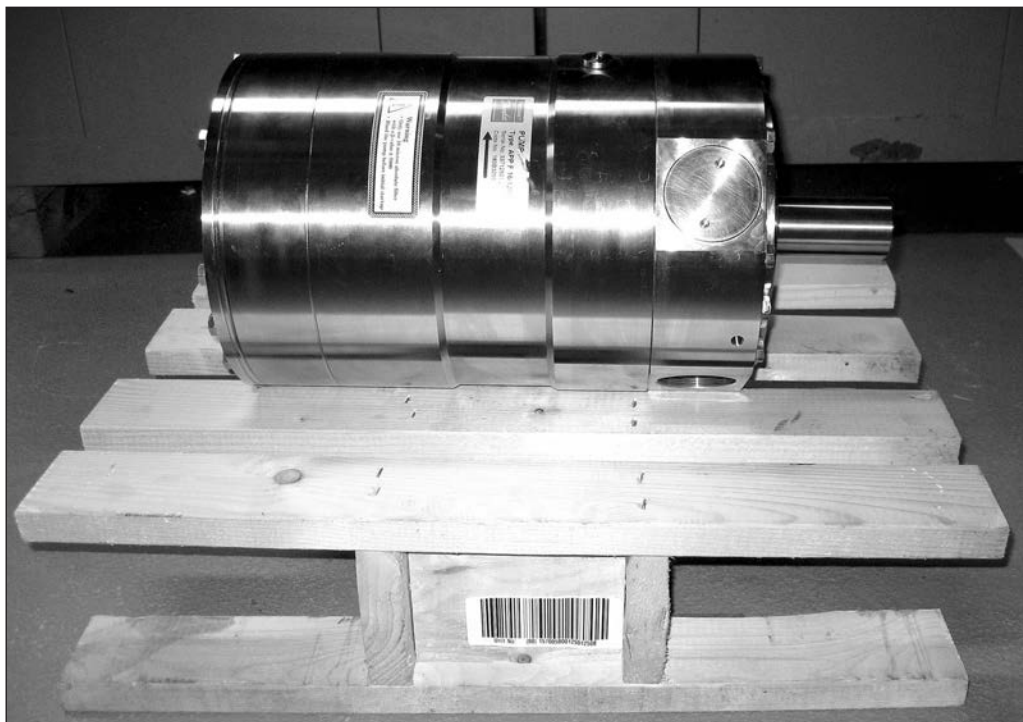
2. Disassembling the pump

1. Disconnect the pump from the rest of the system.
2. Using the 10 mm combination wrench, unscrew the four bolts from shaft seal flange. If shaft seal flange is stuck, place two bolts in threaded holes in shaft seal flange to remove it.
3. Remove ceramic ring from flange by carefully pushing it from the back of the sealing ring.

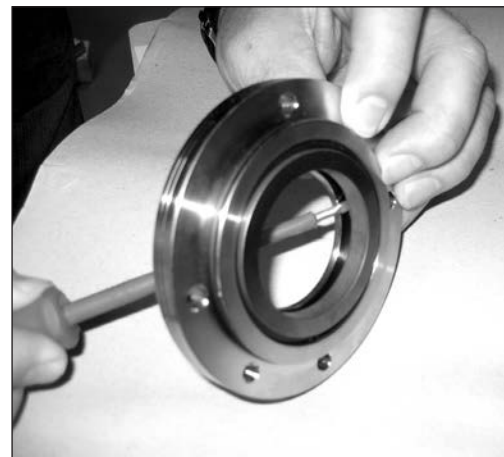
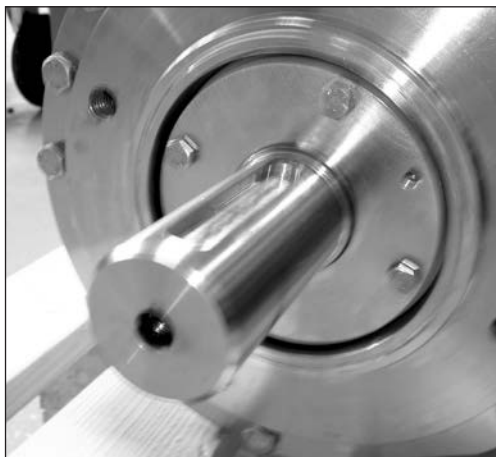

4. Mount the M8 allen screw from the tool set in the top of the shaft.
5. Wet the shaft and shaft seal with clean (filtered) water.

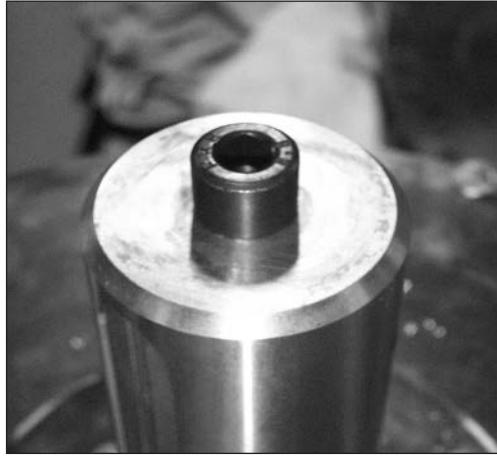

6. Carefully remove the shaft seal using the shaft seal extractor supplied in the toolset. The extractor must fit underneath the shaft seal. Press the arms of the extractor together when turning the bolt.
7. Turn pump into vertical position with shaft pointing downwards. Ensure minimum 100 mm (3,94 inch) free space for the shaft.

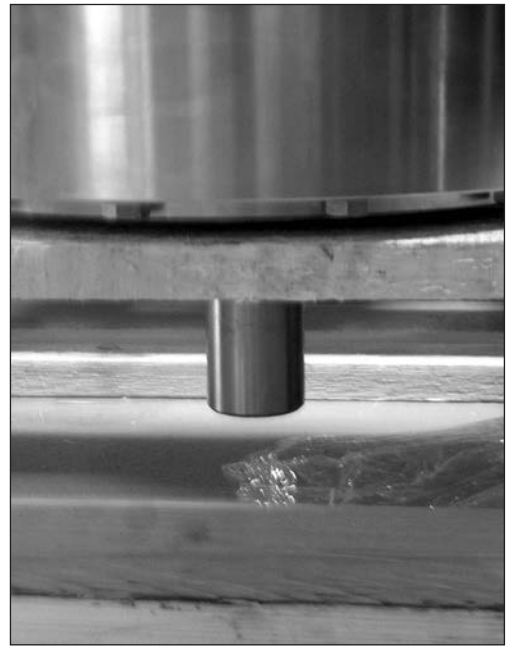

8. Using the 13 mm combination wrench, remove all the bolts on the mounting flange except the three shown in the picture in item 9.
WARNING: Do not loosen the two screws keeping the swash plate in place.



9. Unscrew the remaining three bolts. Turn each bolt one round at the time to make sure that the flange is removed as straight upward as possible.

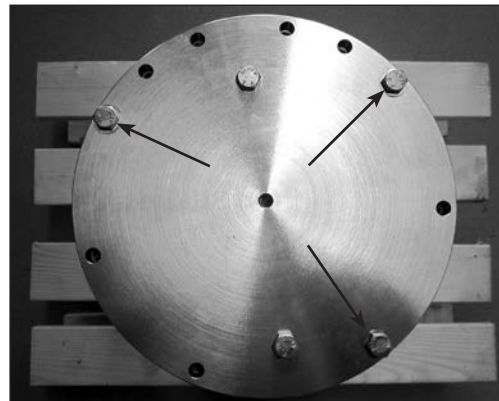

10. Screw the eye bolt in the M8 hole in the middle of the flange. Pull it straight upwards.



11. Swash plate must be placed so that its surface is not scratched. For further disassembling of swash plate, see page 12.

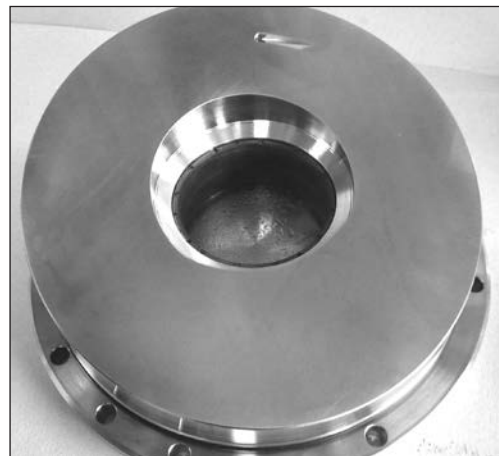

12. Remove the pistons one by one. Be careful not to scratch pistons. Tilt the retainer plate to horizontal for easy removal of pistons, if required.
WARNING: DO NOT USE ANY TOOLS.

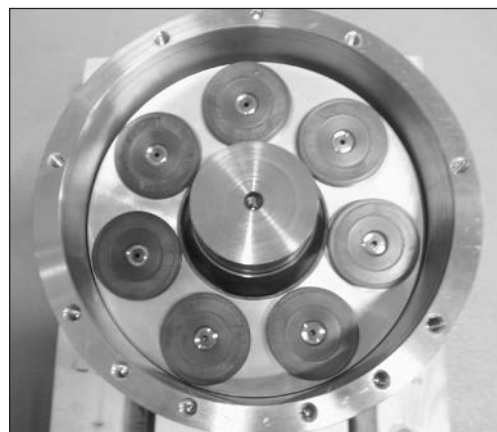

13. Remove the retainer plate.

Note: As the retainer guide is not attached to the retainer plate, it might fall out.

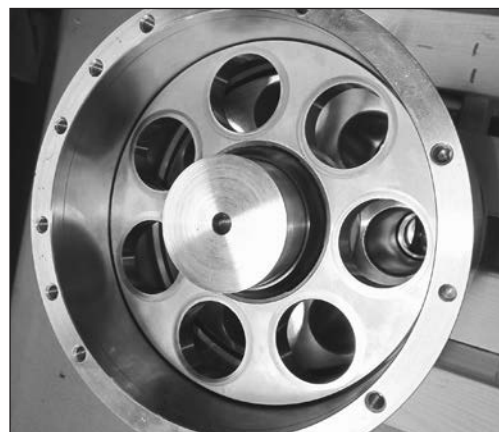

14. Remove the retainer guide, the spring guide, the 7 springs and the 3 pins.



15. Mount the M8 eye bolt in the cylinder barrel. Pull straight upwards. A continuous lift will elevate cylinder barrel out of housing. This can only be done if shaft seal is removed.

WARNING: If the cylinder barrel is dropped into housing, the shaft bearing in the port flange might be damaged. Replacement of the shaft bearing in the port flange can then only be done at Danfoss DK-Nordborg.

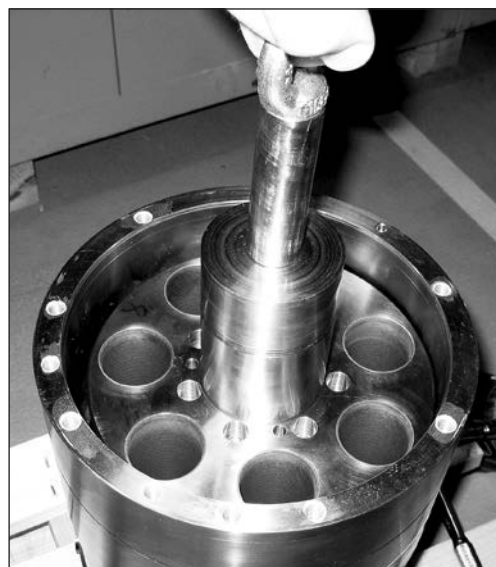

16. Place cylinder barrel horizontal to ensure it can not roll. For further disassembling of cylinder barrel and valve plate see page 13.

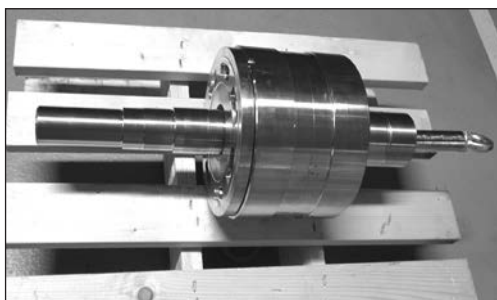

17. Remove the port plate.

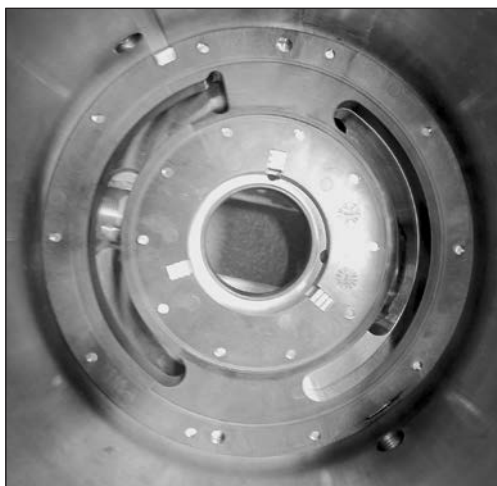

18. Remove the two guide pins.

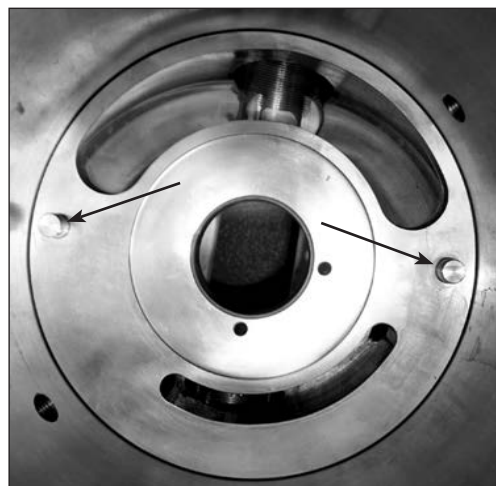

19. Place the pump horizontally.

20. Remove the remaining screws in port flange using the 13 mm combination wrench.

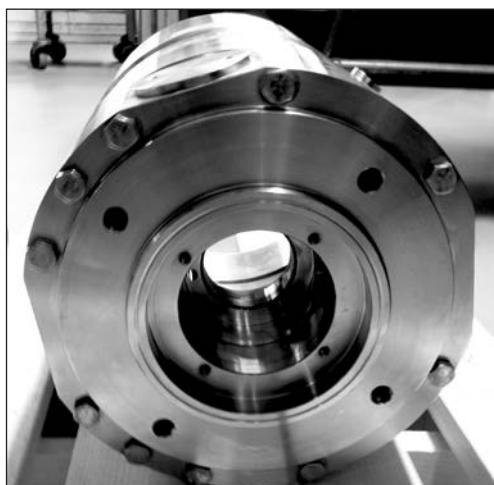

21. Carefully separate house and port flange. Ensure that the guide pin for the positioning of the house is not lost. For further disassembling of flush valve, see page 14.

3. Assembling the pump

Important:

It is essential that the pump is serviced in conditions of absolute cleanliness. All parts must be absolute clean before mounting.

Note: Place the pump on a pallet or other stable surface above the ground. Ensure that the pump cannot roll. It must be possible to place the pump vertically with the shaft pointing downwards. This can be done between two pallets or between two boards on a pallet provided that the distance is minimum 100 mm (3,94 inch) – see photo page 4 paragraph 7.

WARNING:

Do not use silicone when assembling the pump.

Do not reuse disassembled O-rings as they might be damaged. Always use new O-rings. Do not reuse the shaft seal, due to risk of leakage.

1. Lubrication
 - To prevent seizing-up, lubricate threads on screws.
 - O-rings inside pump must be lubricated only with clean filtered water.
 - O-rings for port flange, end flange and black O-ring on flushing valve must be lubricated.
 - It is important to lubricate ALL parts before and during assembling with clean filtered water. (Especially all PEEK parts)



2. Place port flange as illustrated.



3. Insert guide pin for positioning housing on port flange. Ensure that two screw holes can be reached from below.

4. Mount the O-ring. Remember lubrication of the O-ring with clean filtered water.

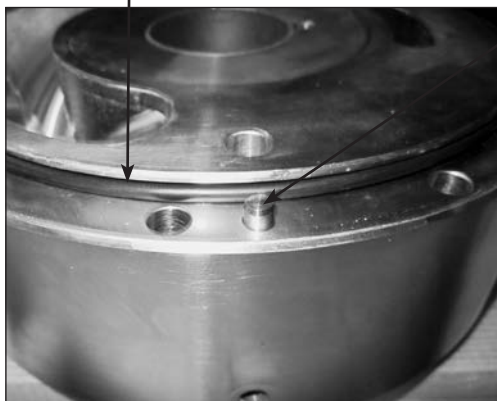

5. Position housing by aligning pin hole over guide pin.

6. Gently press downwards. Be careful not to squeeze the O-ring. If O-ring is damaged the pump will leak.

7. Screw in at least two screws from below.



8. Place housing horizontally. Cross screw the rest of the screws in on port flange. Tighten screws to a torque of 30 ± 2 Nm.

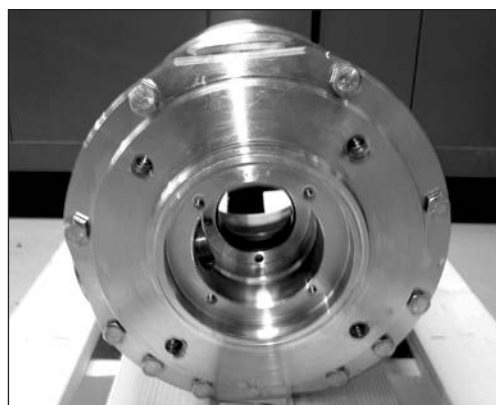

9. Place pump vertically. Place 10.5 mm guide pins in port flange.

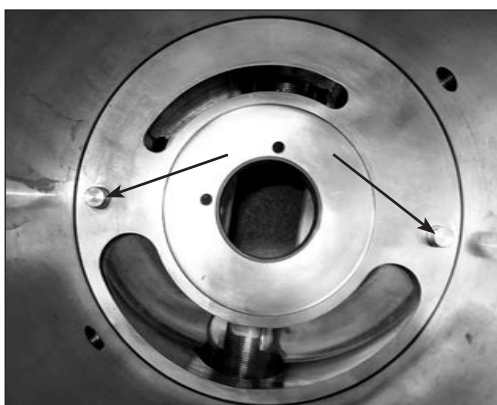

11. Ensure the port plate is fitted tightly against the bottom.

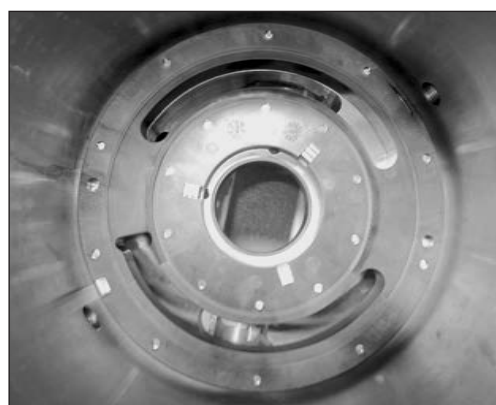

10. Position port plate using the two guide pins. Do not use force for this operation.

Important:
Lubricate port plate with clean filtered water.

If valve plate is disassembled from cylinder barrel please see page 13 before continuing.

12. Screw in M8 eye bolt in the cylinder barrel.

13. Make sure there is enough free space for shaft beneath the housing. Minimum 100 mm (3,94 inch). Carefully lower cylinder barrel into housing.

WARNING:
If cylinder barrel is dropped or lowered too fast into housing, the shaft bearing might be damaged.
 Replacement of the shaft bearing can then only be done at Danfoss DK- Nordborg.

14. Unscrew M8 eye bolt.

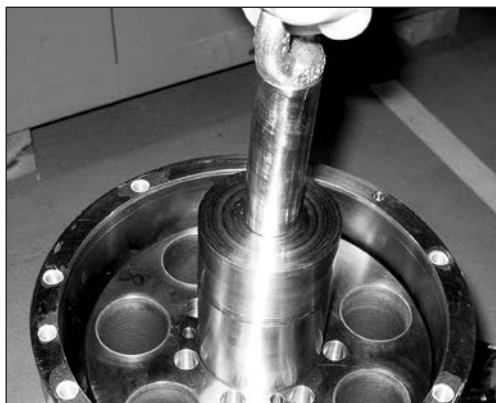

15. Place the 7 springs and 3 pins in cylinder barrel. The pin holes are assymetric.



16. Place the spring guide and the retainer guide on the cylinder shaft.



17. Place retainer plate in cylinder barrel. (Remember to lubricate the retainer plate and cylinder bushings with clean filtered water).



18. Ensure that retainer plate is oriented correctly, with its slant surfaces pointing downwards.

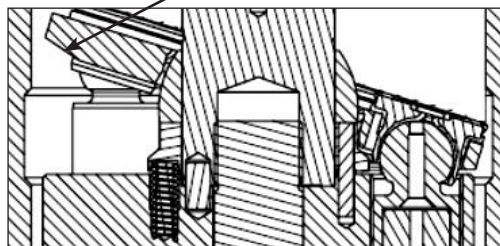

19. Place pistons in retainer plate and cylinder barrel. When pistons are placed, tilt retainer plate for easier placement of swash plate.

20. Place the guide pin in the housing.

If swash plate has been disassembled from mounting flange, see page 12 for assembly of swash plate.

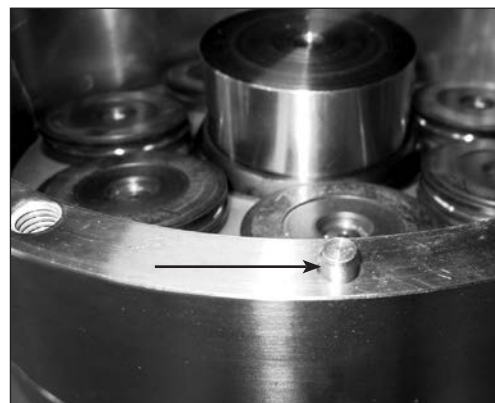
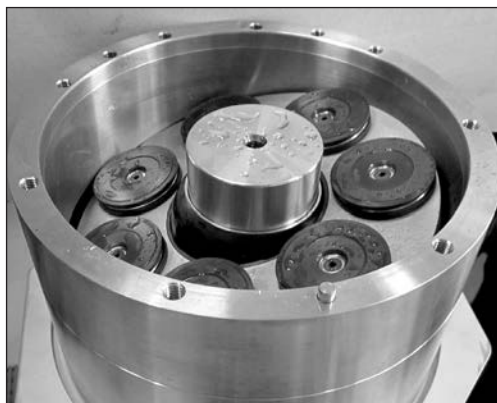

21. Lubricate piston shoes and swash plate with clean filtered water.

22. Mount assembled swash plate, using the guide pin.

23. Place three bolts in mounting flange. (Remember lubrication as stated in paragraph 1 page 7.)
Turn each bolt one round at a time to ensure mounting flange is mounted as straight downwards as possible. Be careful not to squeeze the O-ring.

24. Screw in the rest of the bolts and tighten all screws to a torque of 30 +/- 2 Nm.

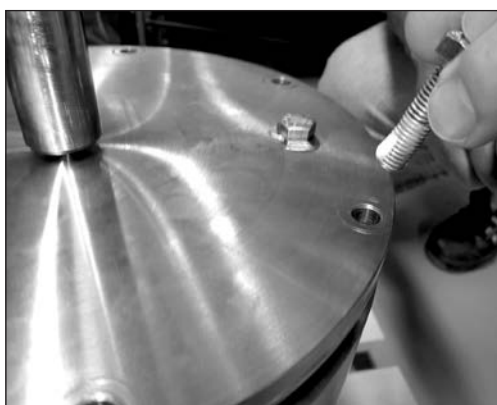

25. Place pump horizontally to get access to shaft.

26. Lubricate shaft with clean filtered water.

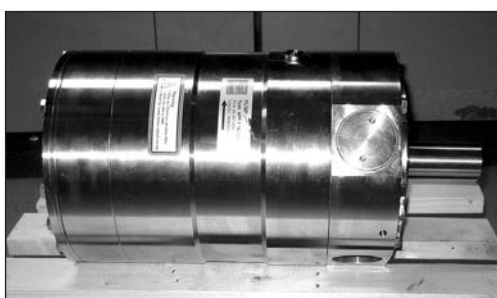

27. Place stop for shaft seal and new shaft seal on shaft.
WARNING: Ensure that carbon ring is pointing outwards. Do not reuse the shaft seal, due to risk of leakage.



28. Use plastic press bush assembly tool provided with large diameter pointing towards seal, to press seal against shoulder of stop for shaft seal.

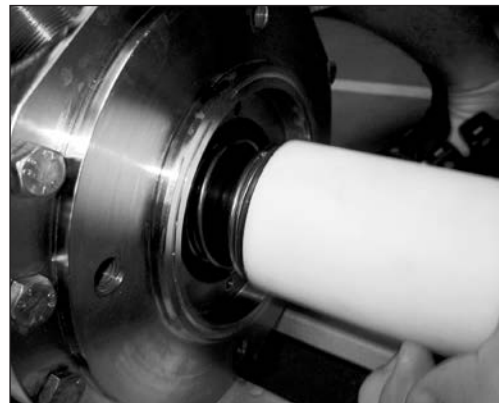

29. Press new ceramic ring into shaft seal flange, using plastic tool provided.
WARNING: Ensure that the face with rubber seal is positioned against shoulder in shaft seal flange. Ensure that ceramic ring is pointing outwards.



30. Remove old O-ring and fit new one on shaft seal flange.

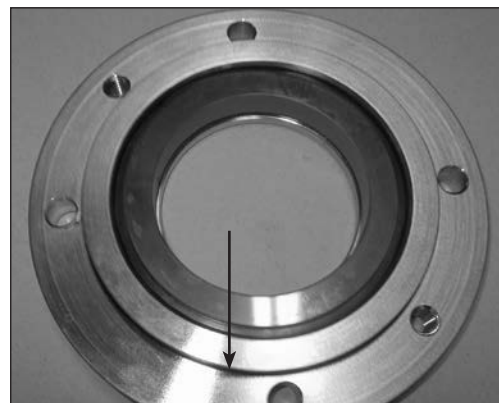

31. Place shaft seal flange on shaft.

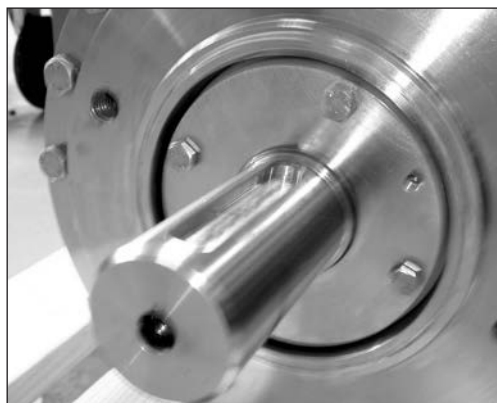

32. Tighten the bolts with a torque of 10 Nm \pm 2 Nm.

4. Disassembling and assembling of the swash plate

WARNING:
Make sure that the surface on the swash plate does not get any marks.

1. Place the swash plate upside down. Remove the 2 bolts holding the swash plate. Remove the mounting flange from the swash plate.

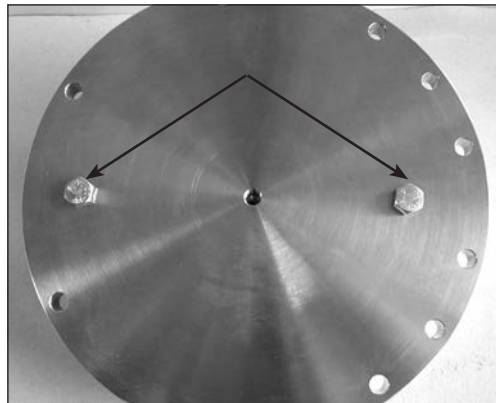

2. Change the O-rings and guide pins. (Provided with sealing set).

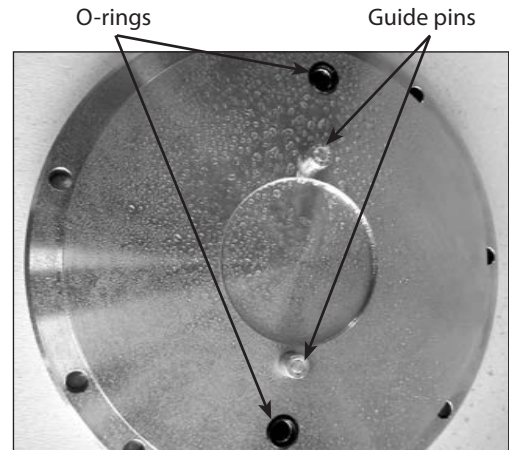

3. Change the O-ring on the mounting flange.



4. Mount the swash plate on the 2 guide pins. Carefully by hand tilt the unit horizontally and mount the 2 bolts which hold the swash plate. Tighten the bolts with a torque of 30 Nm +/- 2 Nm. Finally check the surface on the swash plate for any marks or foreign particles.

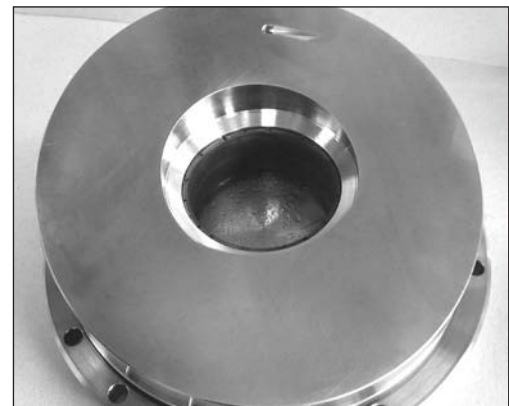

5. Mount the assembled part on the pump. (Remember to lubricate the O-ring).

5. Disassembling and assembling of cylinder barrel/valve plate

1. Push a screwdriver into the hole between the cylinder barrel and valve plate. Carefully push downward the screwdriver so that it makes a gap between cylinder barrel and valve plate. Use this gap to put in another screwdriver and loosen the valve plate from the cylinder barrel.



2. Remove the O-rings and backup rings. If they have been removed they can not be reused. Mount the new back-up rings on the valve plate first and then mount the new O-rings.

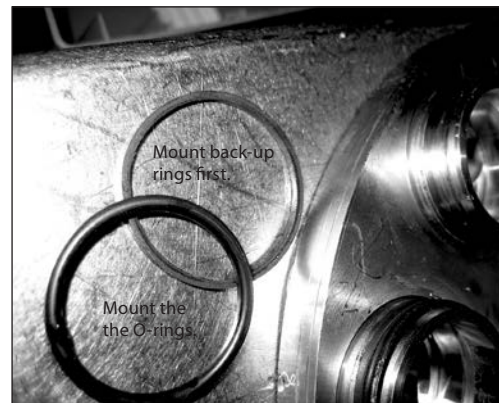

3. Lubricate the new O-rings/back-up rings and the liners in the cylinder barrel with clean filtered water. Lower the valve plate upside down on the cylinder barrel. Place the press bush for valve plate (provided in tool set) like on the picture. Screw the bolt into the shaft in the cylinder barrel and turn the nut slowly clockwise. The valve plate must slide gently into the cylinder barrel. Stop when the gap between cylinder barrel and valveplate is 1-2 mm.

4. Remove the press bush again by screwing the nut counter clockwise. Mount the cylinder barrel into the pump.

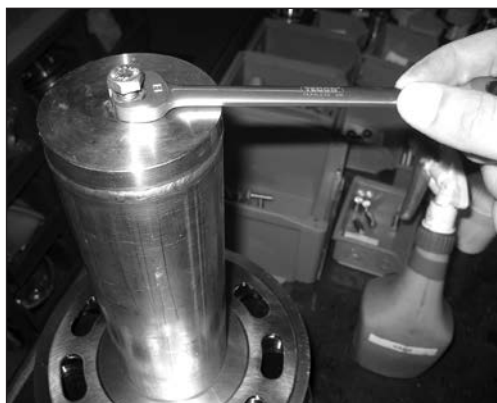

6. Disassembling and assembling of the flush valve

1. Unscrew the flushing valve counter clockwise by using the pin wrench.
2. Remove the o-rings (green and black). If necessary change the valve cone, spring and plug. It is important that if the spring is changed it is located like on the picture. Carefully use a screwdriver. The end of the spring must be against the shoulder of the valve cone.



3. Put a small amount of lubrication on the thread on the plug. Screw it into the port flange. Tighten with a torque of 30 Nm +/- 3 Nm.

7. APP 11-13,
Exploded view

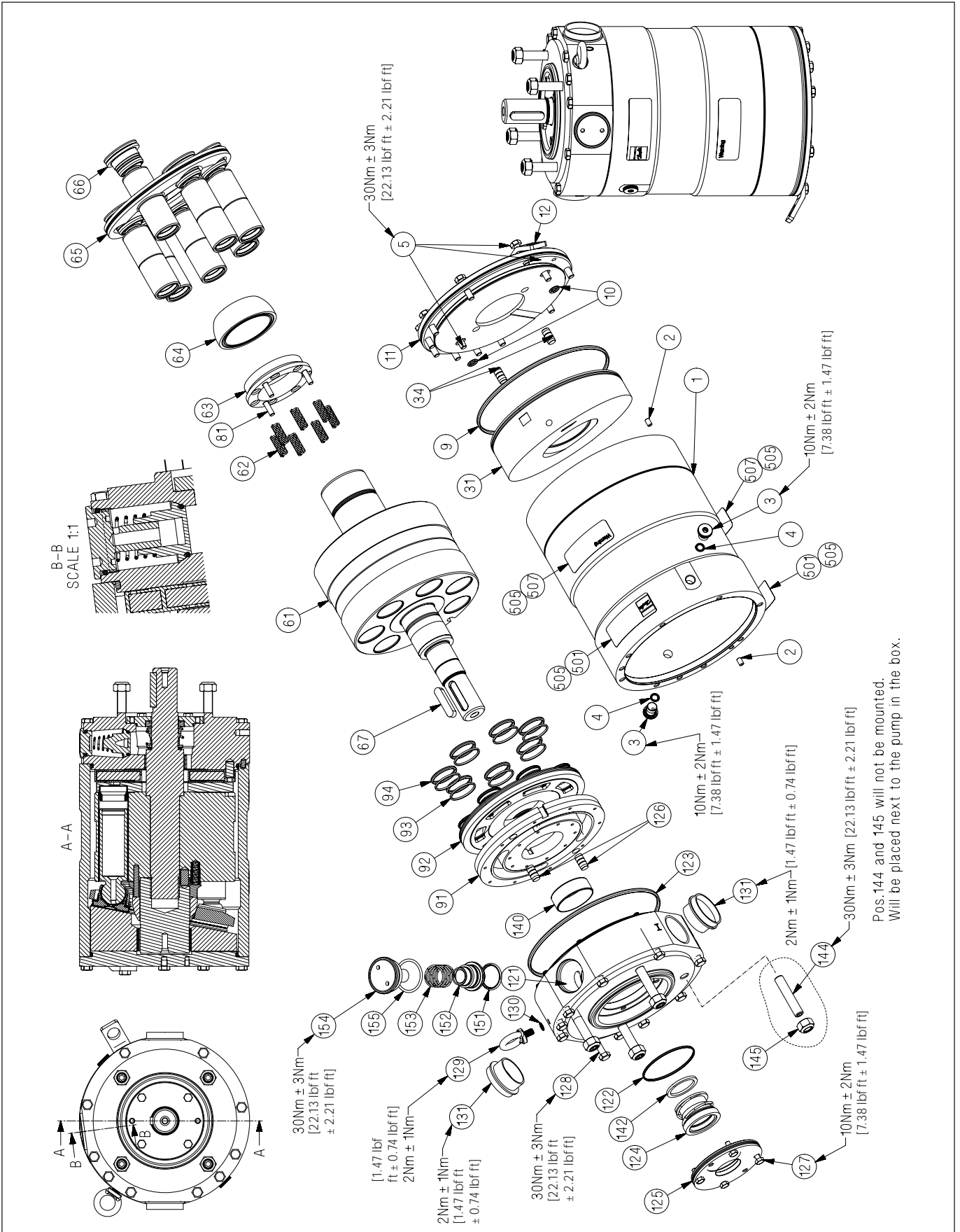

8. APP 16-19,
Exploded view

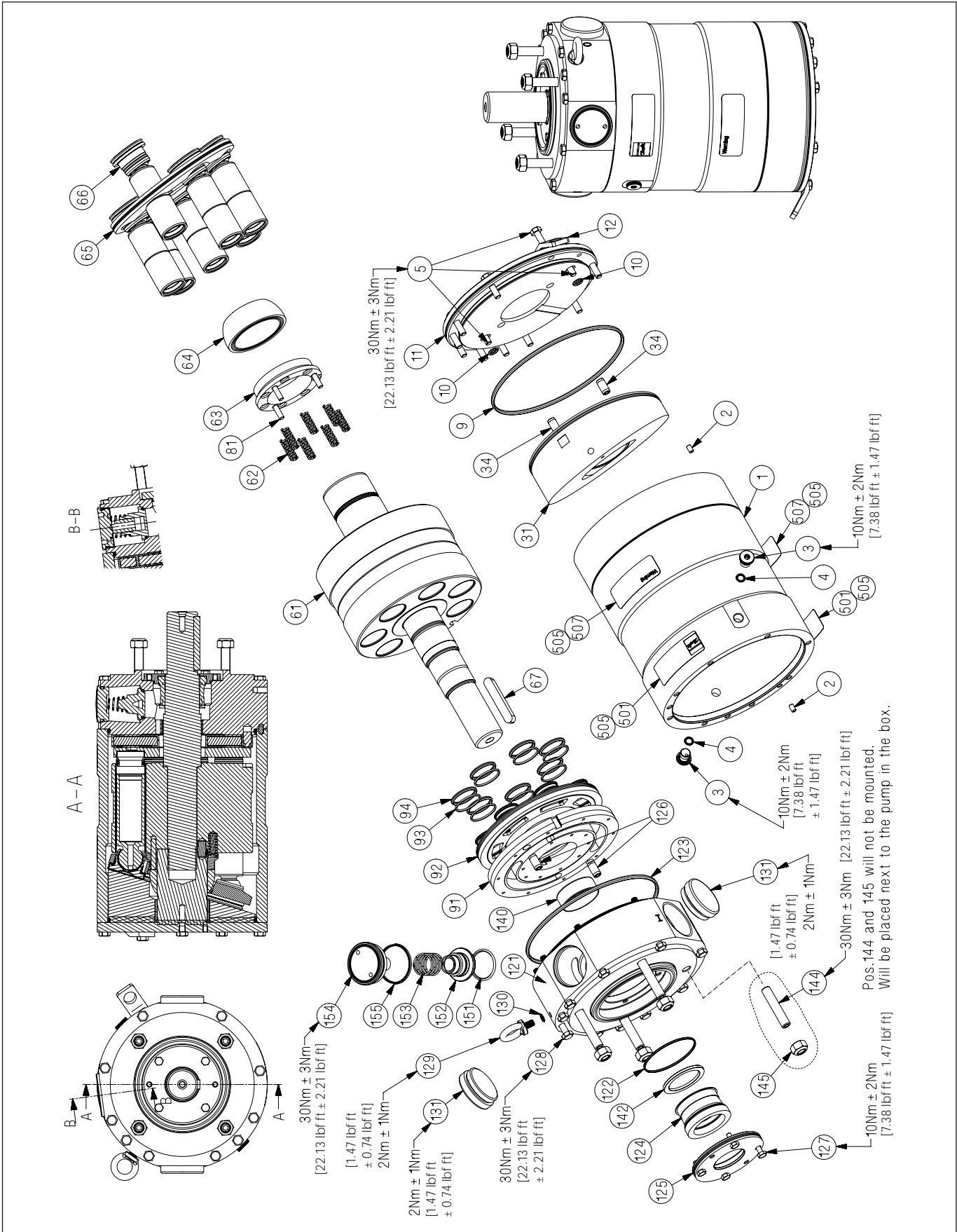

9. APP 22,
Exploded view

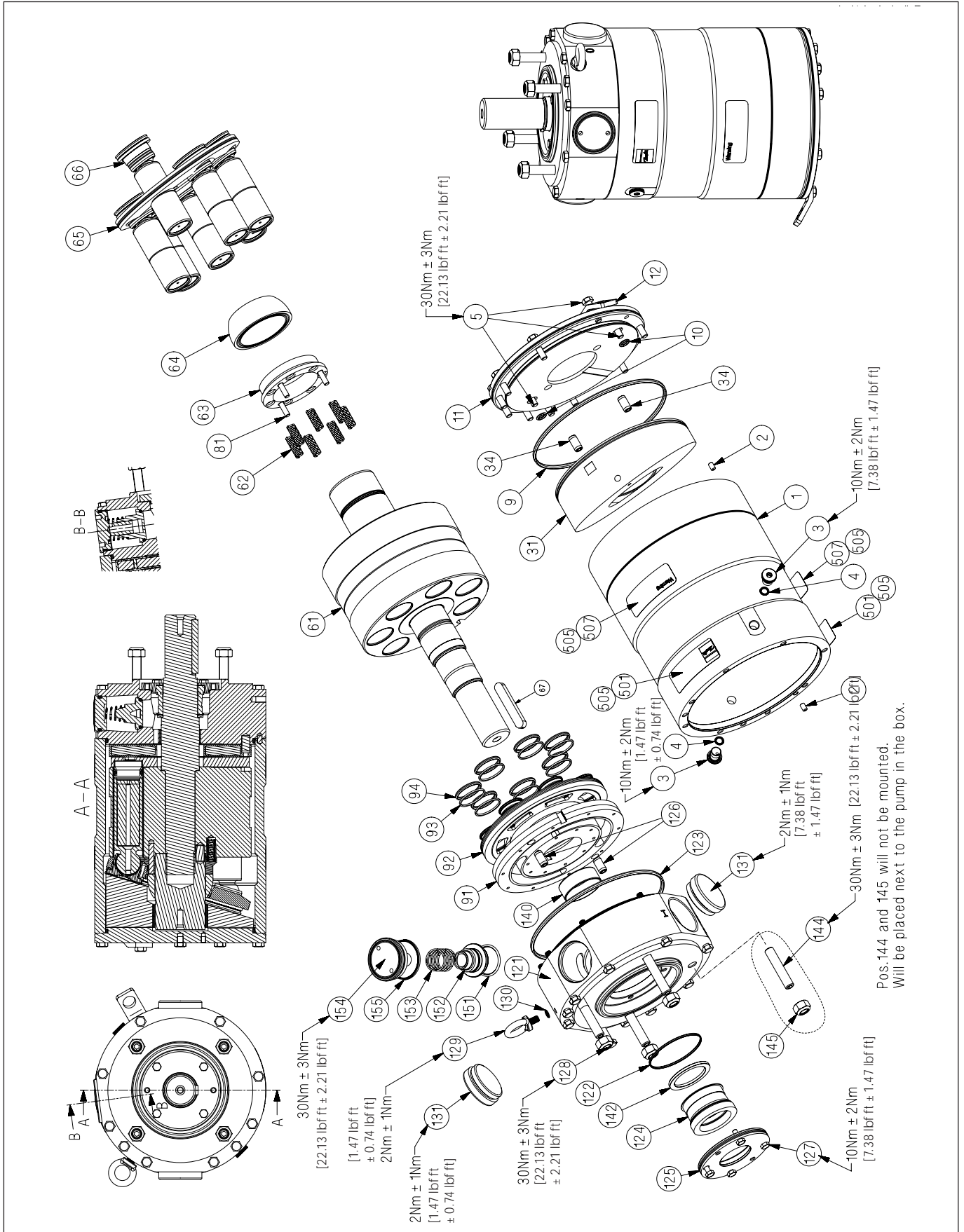

Danfoss A/S
High Pressure Pumps
DK-6430 Nordborg
Denmark

Danfoss can accept no responsibility for possible errors in catalogues, brochures and other printed material. Danfoss reserves the right to alter its products without notice. This also applies to products already on order provided that such alterations can be made without subsequential changes being necessary in specifications already agreed. All trademarks in this material are property of the respective companies. Danfoss and the Danfoss logotype are trademarks of Danfoss A/S. All rights reserved.
